

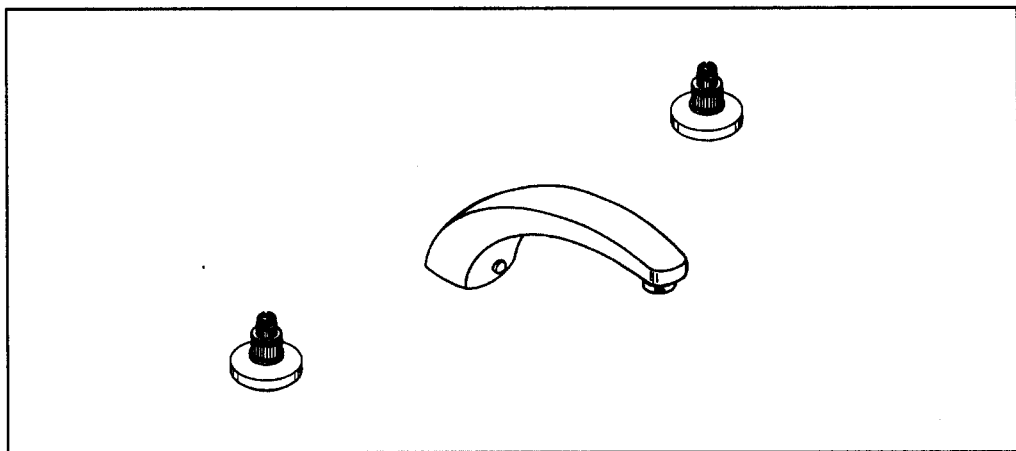

Exquisit Roman Tub Combinations

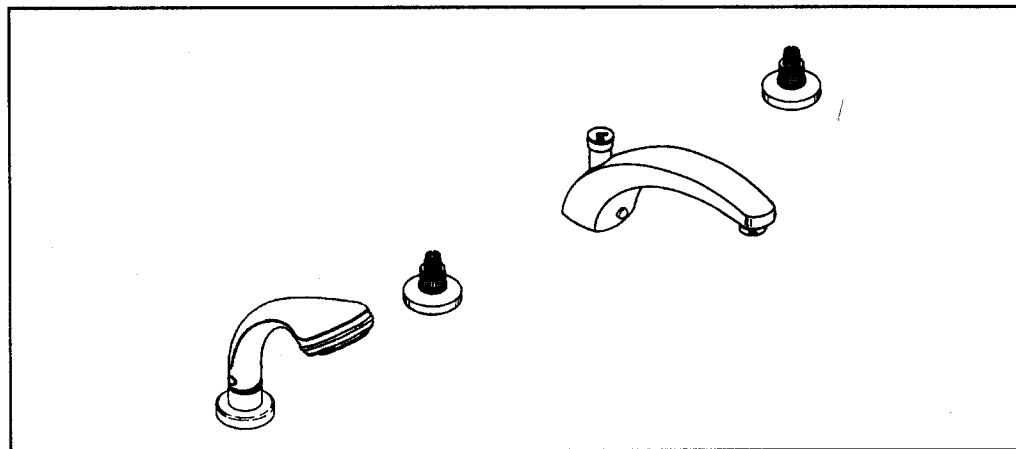

25 621



25 622

Printed on chlorine-free bleached paper.
Imprimé sur papier blanchi sans chlore.
Impreso en papel blanqueado sin cloro.



Installation dimensions
Inch and (mm)

Dimensions d'installation
Pouce et (mm)

Dimensiones de montaje
Pulgadas y (mm)

25 621

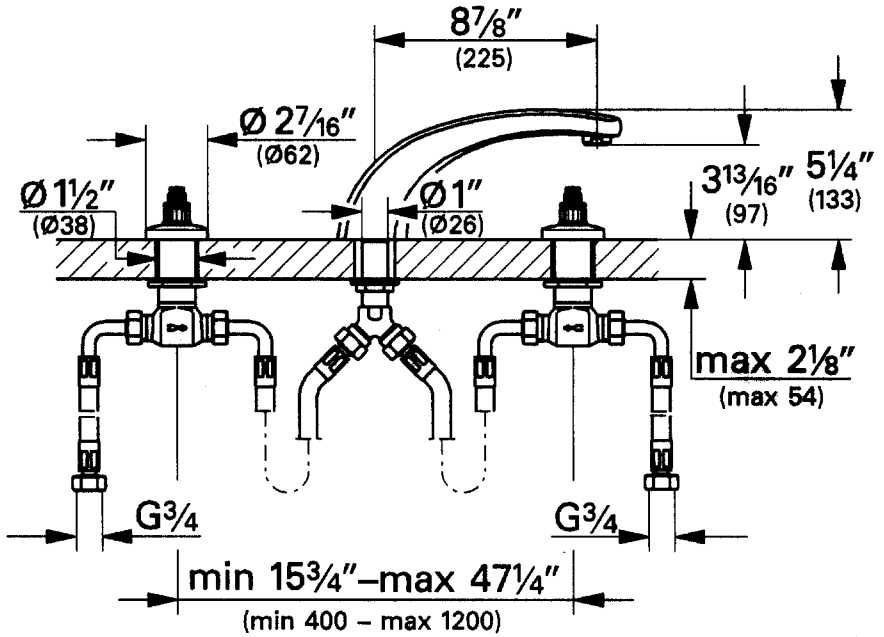

25 622

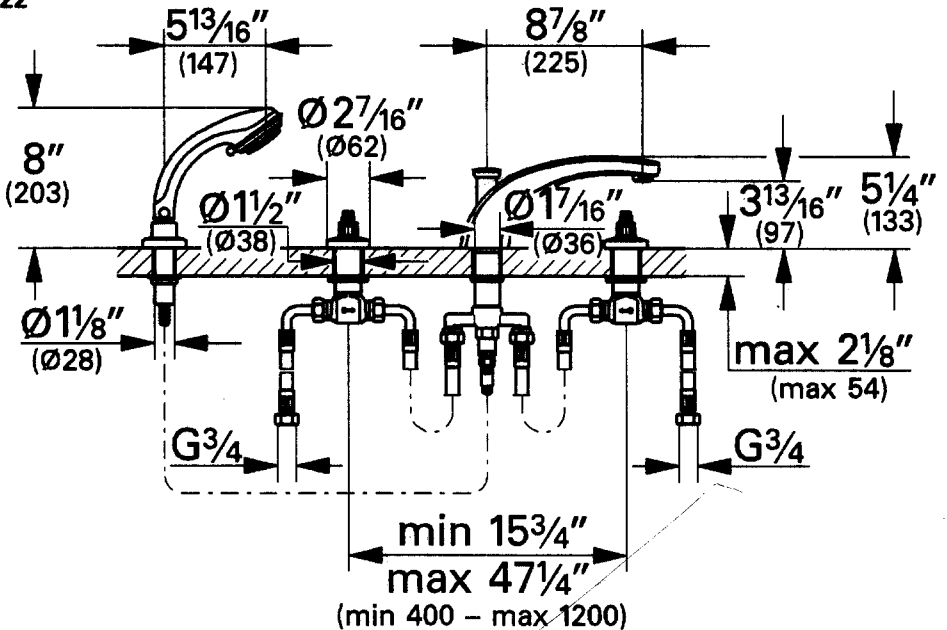

Replacement parts

Pièces de rechange

Repuestos

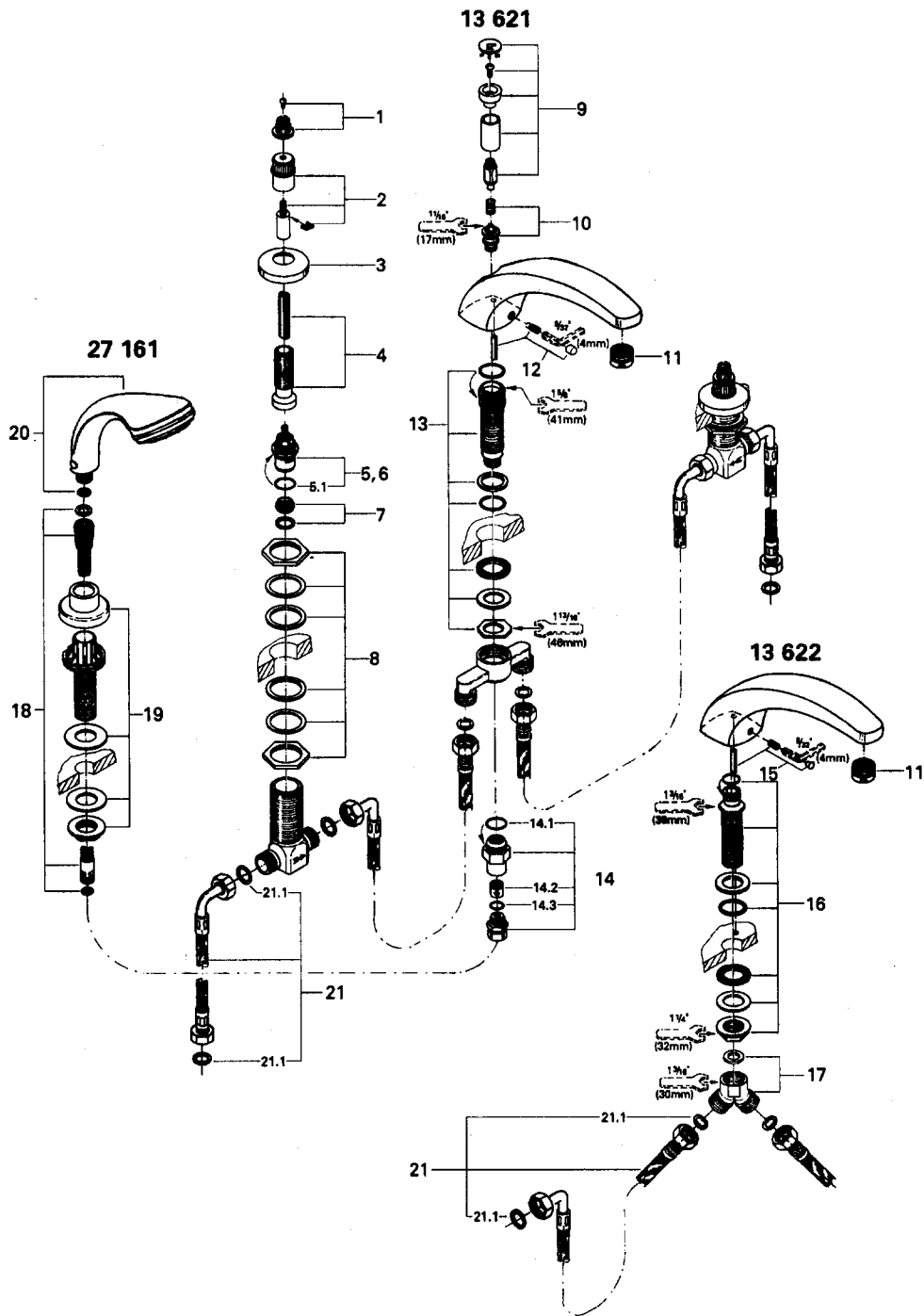

Specification

Application

Operation is possible in conjunction with:

- Pressurized storage heaters
- Thermally controlled instantaneous heaters
- Hydraulically controlled instantaneous heaters

Operation with low-pressure storage heaters (displacement water heaters) is **not** possible.

Specifications

- Flow pressure
 - min. 7.25 psi
 - recommended 14.5 - 72.5 psi
 - greater than 72.5 psi, fit pressure reducing valve
- Max. operating pressure 145 psi
- Test pressure 232 psi
- Flow delivery, see figs. [1] and [2].
- Temperature
 - max. (hot water inlet) 176 °F
 - max. (handshower) 158 °F
- Water connection
 - hot - LH
 - cold - RH

Notes:

- Installation of backflow protection must comply with local codes and regulations.
- An access panel must be provided for access to diverting unit and hose connections.
- Major pressure differences between cold and hot water supply should be avoided.

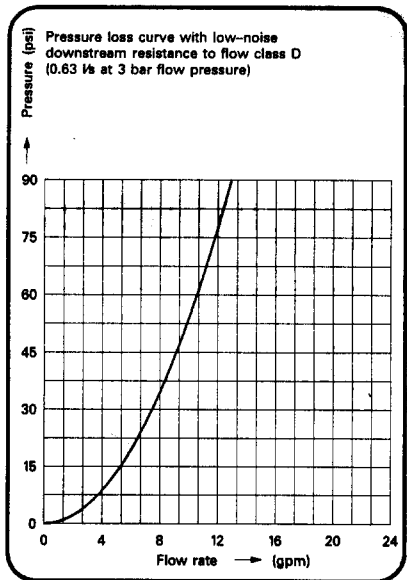

25621

[1]

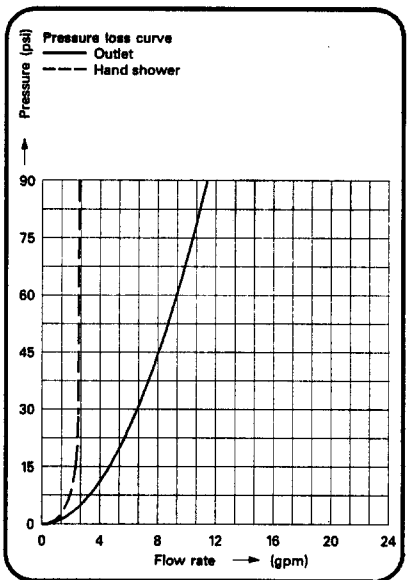

25622

[2]

Installation

Layout dimensions to establish centers and proper clearances, see fig. [3] and Installation dimensions on fold out page I.

Pre assemble components.

Spout

Before mortar and tile is applied, wrap exposed parts with tape to protect threads and opening, Estimate height of tile level and adjust spout shank for proper fit, make sure that tape holds up upper washer and O-ring so that tile can be fitted underneath, see fig. [4].

Side valves

Installation valves and handshower mounting set, see fig. [5].

Left close valve should be mounted on the right (cold) side. Right close valve should be mounted on the left (hot) side.

Valves are marked with a "L" (left close) or "R" (right close) on the top edge of the cartridge.

The distance from the top edge of the handle connection set to the bottom of the escutcheon must be $2\frac{1}{8}$ " (54mm), see fig. [6].

Use $\frac{3}{4}$ " supplies for proper flow.

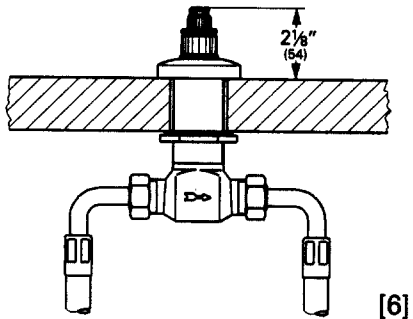
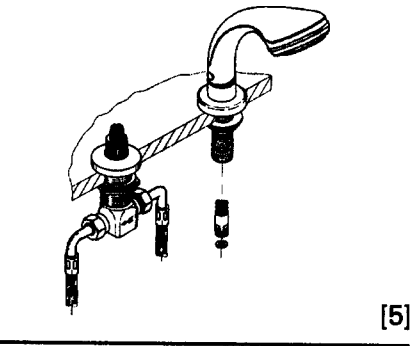
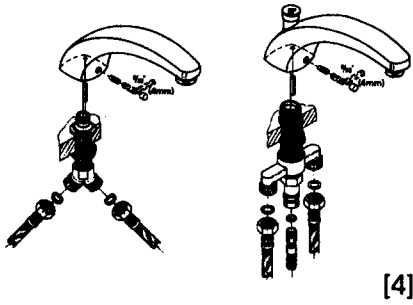
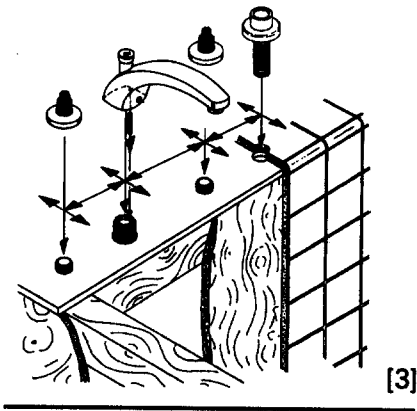

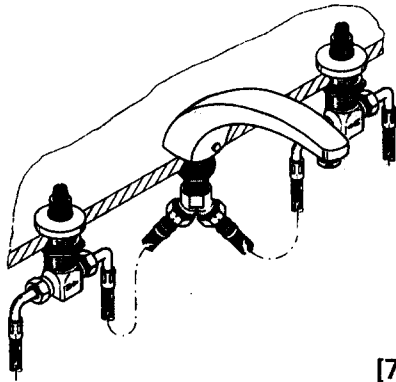

[7]

Flush pipes thoroughly

Connect wide set, see figs. [7] and [8]

For this purpose the side valves must be connected to the angle stops (or other supply points). Do not use additional seals.

The hot water supply should be connected on the left, the cold water supply on the right side.

Open angle stops and check function of faucet.

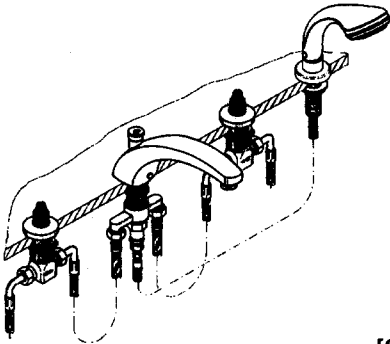

[8]

Check connection for leakage.

Maintenance

For Maintenance, see fig. [9] and fold-out page II.

Shut off cold and hot water supply.

I. Ceramic cartridge

Unscrew the ceramic cartridge (5, 6) using a 17 mm ($1\frac{1}{16}$ ") wrench.

II. Aerator

Unscrew and clean aerator (11), see fig. [3].

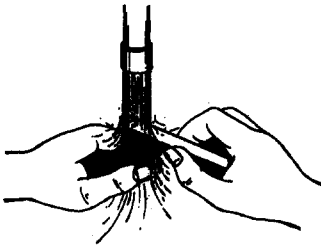

[9]

Check, clean and if necessary replace parts.

Grease with special valve grease (Cat.No. 18 012).

Assemble in reverse order.

Replacement parts/Care

No.	Description	Cat. No.	Pack- ing unit	No.	Description	Cat. No.	Pack- ing unit
1	Handle connection set	45 186	1	14	Shower connection	45 681	1
2	Extension sleeve	45 204	1	14.1	O-ring	03 119	10
3	Escutcheon	05 042	1	14.2	Check valve	08 565	5
4	Extension spindle	45 202	1	14.3	O-ring	01 205	10
5	Ceramic cart. 90°, left	45 887	1	15	Spout fitting set (25 621)	45 682	1
5.1	Body seal O-ring	45 583	10	16	Mounting set (25 621)	45 163	1
6	Ceramic cart. 90°, right	45 888	1	17	Connection set	45 358	1
7	Renewable seat set	45 345	1	18	Shower hose	28 158	1
8	Mounting set side valve	45 444	1	19	Mounting set shower	47 417	1
9	Diverter knob	45 225	1	20	Handshower	28 175	1
10	Diverter cartridge	45 187	1	21	Flexible hose	45 446	1
11	Aerator M28x1	13 939	1	21.1	Washer	01 386	10
12	Spout fitting set (25 622)	45 683	1				
13	Mounting set (25 622)	45 456	1				

Subject to technical modification without notice.

Only original Grohe replacement parts may be used.

Care

Instructions for care of this roman tub combination will be found in the Limited Warranty supplement.

