

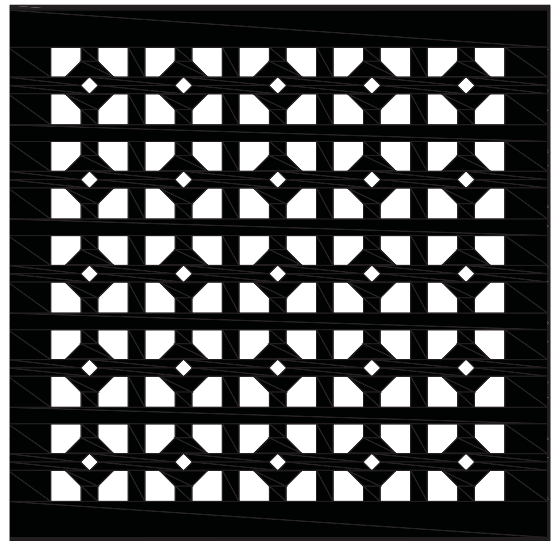

Infinity Drain

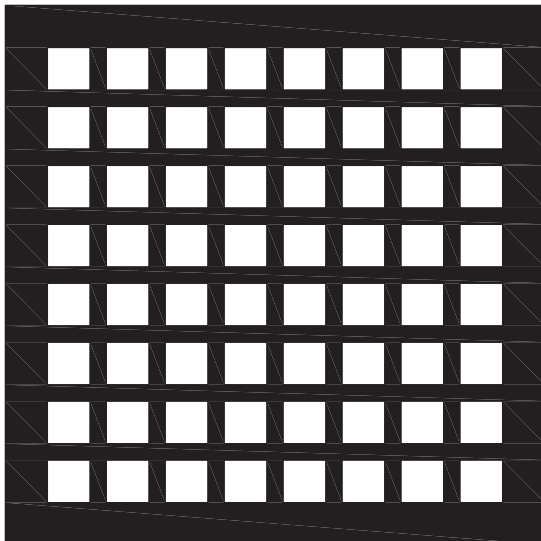
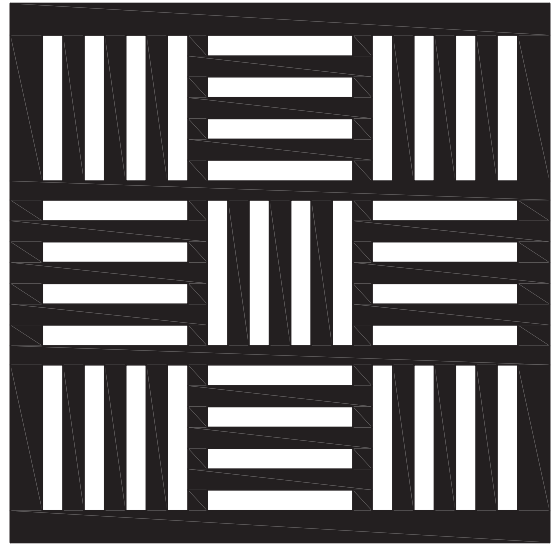

**G Series + LW 5 Series
Supplemental Price Book
January 2015**

Made in the U.S.A

Terms & Conditions

Currency	Unless otherwise indicated, all dollar amounts referred to in these terms and conditions are in United States funds for sales in North America.
Limited Lifetime Warranty	This limited lifetime warranty is extended only to the original purchaser of the unit under warranty and is valid only when bought through and registered by an authorized Infinity Drain retailer.
Exclusions	The above-stated limited lifetime warranty applies as long as damage is not caused by an accident, abuse, misuse, fire, insects, use of abrasive products, or an act of God. Transport, handling or installation damages are also excluded. Any part that must be changed during the warranty period will be covered by the original warranty or for a two (2) year period following replacement, according to the first contingency.
Claims and Returns	All claims for damages and shortages must be reported to Infinity Drain in writing within 5 days after delivery. Returned goods will not be accepted without written authorization. Returns will not be accepted unless an RGA number from Infinity Drain is clearly marked on each box. RGA numbers are valid for 30 days from issue date. All items will be subject to inspection. All items must be returned in original condition. A minimum of 25% or \$25.00 (whichever is greater) will be imposed as a restocking charge. All returned goods must be shipped freight prepaid.
Payment Terms	The Payment Terms are net thirty (30) days from the date of issuance of the invoice. Interest charges of one point five percent (1.5%) per month, eighteen percent (18%) per year, will be charged on all past due accounts. Administrative fees of fifteen percent (15%) will be added to the interest charges on all overdue accounts when payment is obtained through a collection agency.
Restocking Charges	Merchandise may not be returned for any reason without prior written consent from Infinity Drain. Infinity Drain reserves the right to refuse a return on a non-standard drain. Products returned for any reason other than Infinity Drain's error will be subject to a twenty-five percent (25%) restocking and handling charge on the Dealer's base net price, in addition to all applicable charges for labor, materials and/or freight. Product may be returned up to 90 days from date of receipt. Product must be received within 30 days from the RGA date of issue.
Freight Charges	Freight charges apply to drains, as well as residential, commercial and construction site drop shipments. Other shipping charges such as re-consignment, redelivery and storage charges may apply when requested by a dealer or customer. Please contact Infinity Drain order desk for applicable fees.

TABLE OF CONTENTS

G Series	4-7
Residential Strainer.....	4
Residential Drain Assembly.....	5
High Flow Strainer.....	6
High Flow Drain Assembly.....	7
LW 5 Series	8
LW 5 Complete Assembly.....	8
Parts	8

G Series Strainer Magnetically Adheres to Drain Assembly

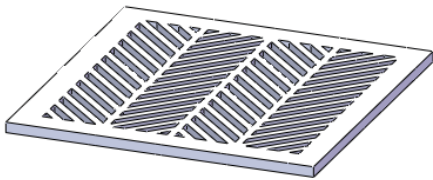

Residential Strainer*

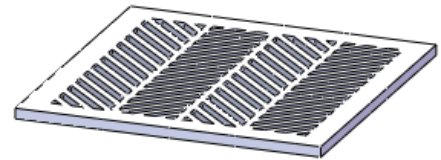

High Flow Strainer*

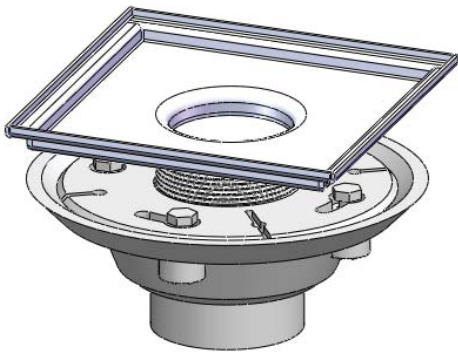

Residential Drain Assembly*

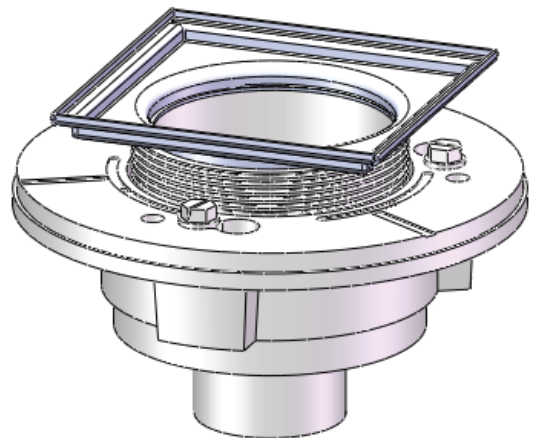

High Flow Drain Assembly*

***G Series Strainer and Drain Assembly Sold Separately**

Residential Strainer

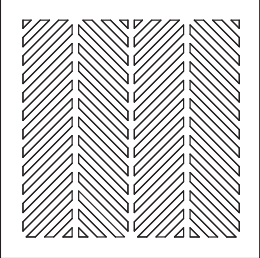
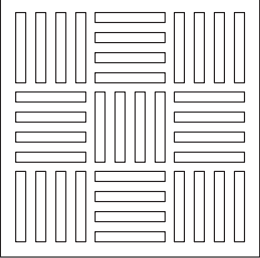
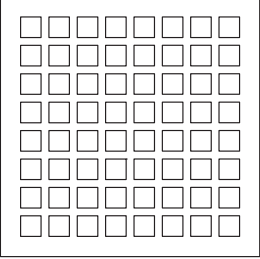
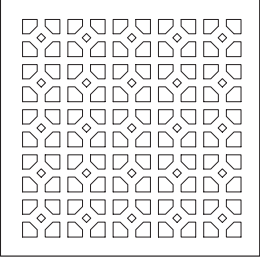
Part 1 of 2	Description	Model	List
	<p>Herring Strainer 5 1/4" x 5 1/4" x 3/16" 304 Stainless Steel</p>	<p>Satin Stainless G 1-SS Polished Stainless G 1-PS Lifetime Oil Rubbed Bronze G 1-ORB</p>	<p>\$175 \$230 \$230</p>
	<p>Line Strainer 5 1/4" x 5 1/4" x 3/16" 304 Stainless Steel</p>	<p>Satin Stainless G 2-SS Polished Stainless G 2-PS Lifetime Oil Rubbed Bronze G 2-ORB</p>	<p>\$175 \$230 \$230</p>
	<p>Square Strainer 5 1/4" x 5 1/4" x 3/16" 304 Stainless Steel</p>	<p>Satin Stainless G 3-SS Polished Stainless G 3-PS Lifetime Oil Rubbed Bronze G 3-ORB</p>	<p>\$175 \$230 \$230</p>
	<p>Otto Strainer 5 1/4" x 5 1/4" x 3/16" 304 Stainless Steel</p>	<p>Satin Stainless G 4-SS Polished Stainless G 4-PS Lifetime Oil Rubbed Bronze G 4-ORB</p>	<p>\$175 \$230 \$230</p>

Residential Drain Assembly



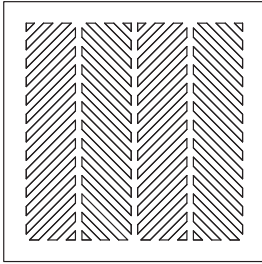
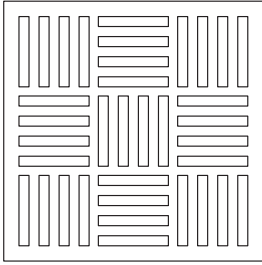
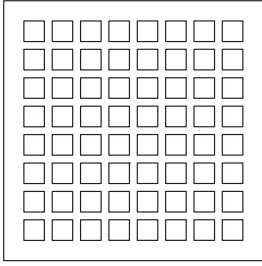
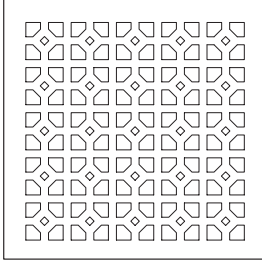

Part 2 of 2	Description	Model	List
 <p>No Hub</p>	<p>CAST IRON</p> <p>Cast Iron 2" No Hub Outlet</p> <p>Includes: Drain Body Hair Catch 2" Throat to Fit Strainer Mud Guard</p>	<p>9 GPM DI 22</p>	<p>\$180</p>
 <p>Threaded</p>	<p>CAST IRON</p> <p>Cast Iron 2" Threaded Outlet</p> <p>Includes: Drain Body Hair Catch 2" Throat to Fit Strainer Mud Guard</p>	<p>9 GPM DT 22</p>	<p>\$195</p>
	<p>PVC</p> <p>PVC 2" Outlet</p> <p>Includes: Drain Body Hair Catch 2" Throat to Fit Strainer Mud Guard</p>	<p>9 GPM DP 22</p>	<p>\$165</p>
	<p>ABS</p> <p>ABS 2" Outlet</p> <p>Includes: Drain Body Hair Catch 2" Throat to Fit Strainer Mud Guard</p>	<p>9 GPM DA 22</p>	<p>\$165</p>

High Flow Strainer





Part 1 of 2	Description	Model	List
	<p>Herring Strainer 5 1/4" x 5 1/4" x 3/16" 304 Stainless Steel</p>	<p>Satin Stainless G 1-SS Polished Stainless G 1-PS Lifetime Oil Rubbed Bronze G 1-ORB</p>	<p>\$175 \$230 \$230</p>
	<p>Line Strainer 5 1/4" x 5 1/4" x 3/16" 304 Stainless Steel</p>	<p>Satin Stainless G 2-SS Polished Stainless G 2-PS Lifetime Oil Rubbed Bronze G 2-ORB</p>	<p>\$175 \$230 \$230</p>
	<p>Square Strainer 5 1/4" x 5 1/4" x 3/16" 304 Stainless Steel</p>	<p>Satin Stainless G 3-SS Polished Stainless G 3-PS Lifetime Oil Rubbed Bronze G 3-ORB</p>	<p>\$175 \$230 \$230</p>
	<p>Otto Strainer 5 1/4" x 5 1/4" x 3/16" 304 Stainless Steel</p>	<p>Satin Stainless G 4-SS Polished Stainless G 4-PS Lifetime Oil Rubbed Bronze G 4-ORB</p>	<p>\$175 \$230 \$230</p>

High Flow Drain Assembly

2" OUTLETS

Part 2 of 2	Description	Model	List
 <p>No Hub</p>	CAST IRON Cast Iron 2" No Hub Outlet Includes: Drain Body Hair Catch 4" Throat to Fit Strainer Mud Guard	21 GPM DI 42	\$215
 <p>Threaded</p>	CAST IRON Cast Iron 2" Threaded Outlet Includes: Drain Body Hair Catch 4" Throat to Fit Strainer Mud Guard	21 GPM DT 42	\$275
	PVC PVC 2" Outlet Includes: Drain Body Hair Catch 4" Throat to Fit Strainer Mud Guard	21 GPM DP 42	\$215
	ABS ABS 2" Outlet Includes: Drain Body Hair Catch 4" Throat to Fit Strainer Mud Guard	21 GPM DA 42	\$215

3" OUTLETS

Part 2 of 2	Description	Model	List
 <p>No Hub</p>	CAST IRON Cast Iron 3" No Hub Outlet Includes: Drain Body Hair Catch 4" Throat to Fit Strainer Mud Guard	30 GPM DI 43	\$250
 <p>Threaded</p>	CAST IRON Cast Iron 3" Threaded Outlet Includes: Drain Body Hair Catch 4" Throat to Fit Strainer Mud Guard	30 GPM DT 43	\$290
	PVC PVC 3" Outlet Includes: Drain Body Hair Catch 4" Throat to Fit Strainer Mud Guard	30 GPM DP 43	\$250
	ABS ABS 3" Outlet Includes: Drain Body Hair Catch 4" Throat to Fit Strainer Mud Guard	30 GPM DA 43	\$250

LW 5 Drain Assembly

Part 1 of 1	Description	Model	List
 <p>No Hub</p>	<p>LW 5 Strainer + Cast Iron 2" No Hub Drain 9 GPM</p> <p>5 1/16" x 5 1/16" x 5/16" 304 18 Gauge Stainless Steel Strainer fastened by 4 screws.</p> <p>Includes:</p> <p>L 5-2 Strainer Cast Iron 2" No Hub Drain Body</p> <p>Satin Stainless Polished Stainless Lifetime Oil Rubbed Bronze</p>	<p>LW 5 2I-SS LW 5 2I-PS LW 5 2I-ORB</p>	<p>\$160 \$170 \$170</p>
	<p>LW 5 Strainer + PVC 2" Drain 9 GPM</p> <p>5 1/16" x 5 1/16" x 5/16" 304 18 Gauge Stainless Steel Strainer fastened by 4 screws.</p> <p>Includes:</p> <p>L 5-2 Strainer PVC 2" No Hub Drain Body</p> <p>Satin Stainless Polished Stainless Lifetime Oil Rubbed Bronze</p>	<p>LW 5 2P-SS LW 5 2P-PS LW 5 2P-ORB</p>	<p>\$145 \$155 \$155</p>
	<p>LW 5 Strainer + ABS 2" Drain 9 GPM</p> <p>5 1/16" x 5 1/16" x 5/16" 304 18 Gauge Stainless Steel Strainer fastened by 4 screws.</p> <p>Includes:</p> <p>L 5-2 Strainer ABS 2" No Hub Drain Body</p> <p>Satin Stainless Polished Stainless Lifetime Oil Rubbed Bronze</p>	<p>LW 5 2A-SS LW 5 2A-PS LW 5 2A-ORB</p>	<p>\$145 \$155 \$155</p>
Additional Parts	Description	Model	List
	G Series Residential 2" Hair Catch	HS 2	\$12
	G Series High Flow 4" Hair Catch	HS 4	\$20
	G Series Residential 5" x 5" Stainless Steel 2" Throat with Mud Guard. Fits standard residential drain bodies (Oatey™, Sioux Chief™, Jones Stevens™, and ProFlo™).	T 2	\$115
	G Series High Flow 5" x 5" Stainless Steel 4" Throat with Mud Guard. Fits MiFab™ and Watts™.	T 4	\$115
	L 5-2 Strainer Only. 5 1/16" x 5 1/16" x 5/16" 18 Gauge 304 Stainless Steel. Strainer fastened by 4 screws. Fits std. residential drain.	L 5 2-SS L 5 2-PS L 5 2-ORB	\$95 \$105 \$105
	5" x 5" Mud Guard. Used inside throat during installation of finished flooring material. This item comes standard with G Series.	MG 5	\$7.50
	Hot Mop Adapter 6 1/2" overall diameter x 2" throat. Allows adaptation to hot mop type drain bodies; Oatey 151, EZ test, and Frank Pattern Instant Set. Works with 2" threaded nipples TNAS + S50 in S series + FX series products (except FX 125).	UCP 2	\$25